

## Effective Lighting Score (ELS)

### ***Abstract***

Off-road (OHV) lights are not limited by the same regulations as on-road (SAE or DOT) lights but lack specifications that adequately quantify the characteristics of their performance. Current off-road lighting standards typically only specify center beam distance and total output. Distance and output are not adequate specifications for off-road light users to select the best light for their application.

Baja Designs has worked to introduce new specifications that can be used to characterize ideal lighting solutions for off-road applications. Modified LM-79 light performance testing was performed on a sampling of 44 Baja Designs and competitors lights to determine actual light performance values. Subsequently, new specifications were derived to characterize how the lights' beam patterns will appear and perform. A new benchmark for the minimum amount of light these specifications are measured to has also been defined.

Baja Designs introduces the Effective Lighting Score (ELS), a four-part evaluation that fully describes the characteristics of the light.

### ***Introduction***

Off-road racing and recreational lights are not limited by the same rules as on-road DOT compliant lights, leaving no ceiling in performance. With that in mind, consumers in the off-road market desire bright lights with sufficient distribution to improve visibility while driving over all types of terrain. An ideal lighting package will inspire driver confidence by eliminating dark spots in the driver's field of view while the vehicle pitches and rolls. Traditionally off-road lights have been described using only Raw or Theoretical lumens (the amount of light) and the distance (how far the light shines). Through years of research and development, Baja Designs has determined that the most important quality of a light is the amount of free light that exists outside of the main beam pattern that creates a smooth transition of light from the center to the peripheral that reduces eye strain in recognizing obstacles and improves endurance. The smooth distribution of light benefits the driver's experience but is not well represented by the aforementioned industry standard specifications of peak beam intensity, total raw or theoretical lumens, and distance at a randomly derived lux (typically 1 or .25). To address this, Baja Designs has developed the Effective Lighting Score (ELS), which is a collection of four measurements to illustrate the true performance of an off-road light.

### ***Theory***

The Effective Lighting Score is broken down as follows:

Blend Angle / Blendability / Light Distance / Light Output

How wide is the usable beam? / How smooth is the pattern? / How far does it go? / How much light?

(Blend Angle, in degrees, to 10 lux) / (Blendability, 0-10 scale) / (Feet, to 10 lux) / (Effective Lumens)

**Blend Angle and Blendability:** Blend Angle and Blendability are new terms Baja Designs is using to help explain the spread and smoothness of the light. The Blend Angle is the angle of light where the brightness of the beam diminishes to 10 lux (94 candela at a distance of 10 feet from the light) while being measured in accordance with LM-79 standards.

Blend Angle and Blendability are derived using a similar practice to zonal lumens defined from ANSI/IES LS-6-20 [2]. Zonal lumens are a current industry standard measurement to show the amount of light accumulated in a conical solid angle.

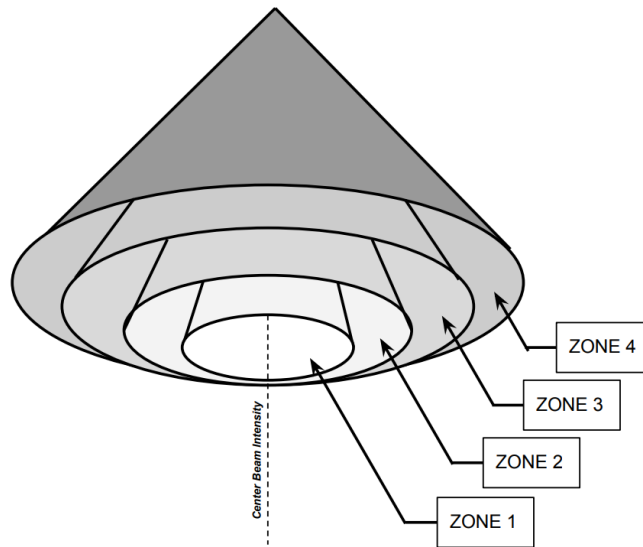

**Picture 1: Zonal Lumens Conic Angles**

This measurement can be very helpful when validating light spread but has a drawback in that it calculates the intensity of a light in all angles and takes the average and does not address horizontal and vertical spread separately. With architectural lighting, this measurement would suffice, but with automotive or off-road lighting it does not form an accurate representation of how light is distributed. Picture 2 shows an example isolux plot from an LM-79 test report showing a light's pattern head on.

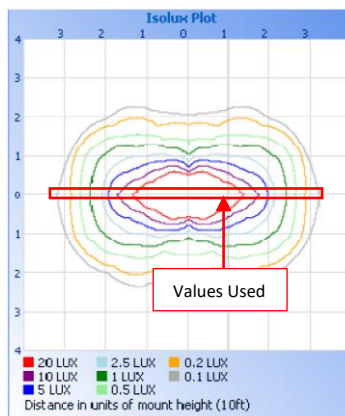

**Picture 2: LM-79 isolux plot showing the horizontal planar angle of zonal lumens used to calculate Blend Angle and Blendability**

Note how the shape of the light's intensity is much wider than it is tall. This characteristic is designed into the light to maximize the width of the beam pattern while providing sufficient vertical light spread. This design is derived from the driver's field of view. Picture 3 and Picture 4, below, provide a representation of how the field of view is limited to a greater degree in the vertical direction.

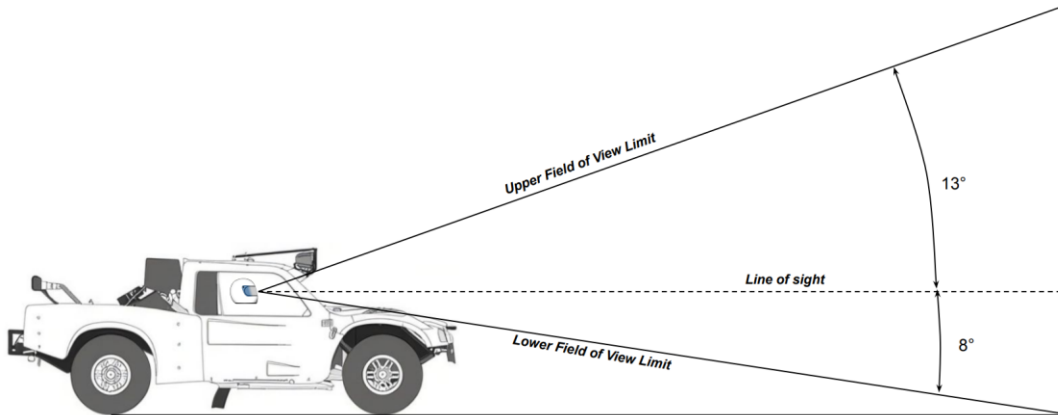

**Picture 3: Vertical driver field of view [5]**

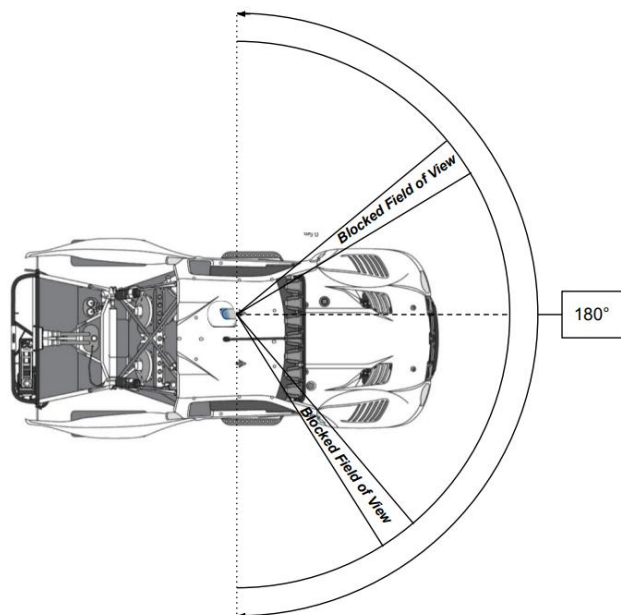

**Picture 4: Horizontal driver field of view [5]**

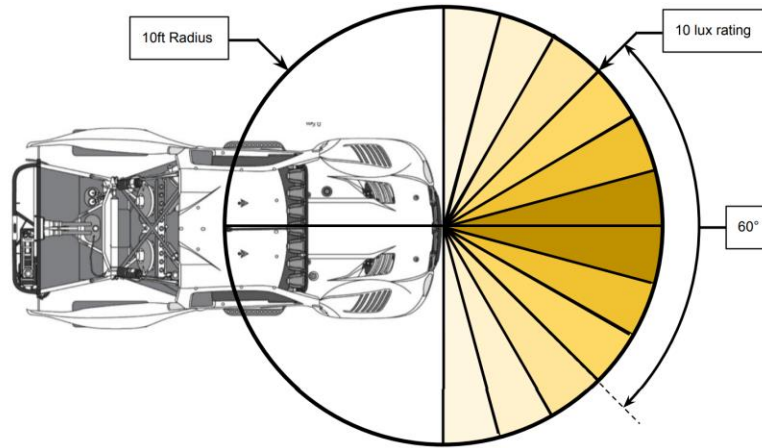

Picture 5: Blend Angle Example of 60° - the maximum angular width of the beam pattern that reaches 10 lux [5]

Since the light's beam is wider than it is tall, it is not useful to combine the horizontal and vertical zonal lumen values. Combining the horizontal and vertical zonal lumen values would mathematically decrease the high values and increase the low values, eliminating the engineered shape of the light. Because the horizontal spread is significantly larger, ELS uses the brightness in the horizontal section of the LM-79 isolux plot, creating a planar angle rather than a conic angle that more accurately represents the spread of an automotive or off-road light.

Using the zonal lumen values of the horizontal planar angle only, a Blendability score of 0-10 score can be derived (refer to *Blendability Score Derivation* below). Blendability describes how evenly lumens are distributed across the light's horizontal beam to 180° (90° left and right of photometric center of light). Scores of 0 and 10 are theoretical limits to this scale. A score of 0 describes a light with a very intense center beam where 100% of the illumination is in the first zone from center and a score of 10 describes a light with perfectly equal illumination through each zone to 180° (refer to Table 1). Pictures 6 and 7 are intended to provide a visual representation of the zones used to calculate Blendability, though it is important to note that there are actually 36 total zones in five-degree increments from 0° (at photometric center of the light) to 90° on either side of the light.

| Angle Range | Lumens | Percent |
|-------------|--------|---------|
| 0-5         | 1500   | 100.00  |
| 5-10        | 0      | 0.00    |
| 10-15       | 0      | 0.00    |
| 15-20       | 0      | 0.00    |
| 20-25       | 0      | 0.00    |
| 25-30       | 0      | 0.00    |
| 30-35       | 0      | 0.00    |
| 35-40       | 0      | 0.00    |
| 40-45       | 0      | 0.00    |
| 45-50       | 0      | 0.00    |
| 50-55       | 0      | 0.00    |
| 55-60       | 0      | 0.00    |
| 60-65       | 0      | 0.00    |
| 65-70       | 0      | 0.00    |
| 70-75       | 0      | 0.00    |
| 75-80       | 0      | 0.00    |

| Angle Range | Lumens | Percent |
|-------------|--------|---------|
| 0-5         | 83.33  | 5.56    |
| 5-10        | 83.33  | 5.56    |
| 10-15       | 83.33  | 5.56    |
| 15-20       | 83.33  | 5.56    |
| 20-25       | 83.33  | 5.56    |
| 25-30       | 83.33  | 5.56    |
| 30-35       | 83.33  | 5.56    |
| 35-40       | 83.33  | 5.56    |
| 40-45       | 83.33  | 5.56    |
| 45-50       | 83.33  | 5.56    |
| 50-55       | 83.33  | 5.56    |
| 55-60       | 83.33  | 5.56    |
| 60-65       | 83.33  | 5.56    |
| 65-70       | 83.33  | 5.56    |
| 70-75       | 83.33  | 5.56    |
| 75-80       | 83.33  | 5.56    |

| Angle Range | Lumens | Percent |
|-------------|--------|---------|
| 0-5         | 850    | 56.67   |
| 5-10        | 300    | 20.00   |
| 10-15       | 50     | 3.33    |
| 15-20       | 275    | 18.33   |
| 20-25       | 25     | 1.67    |
| 25-30       | 0      | 0.00    |
| 30-35       | 0      | 0.00    |
| 35-40       | 0      | 0.00    |
| 40-45       | 0      | 0.00    |
| 45-50       | 0      | 0.00    |
| 50-55       | 0      | 0.00    |
| 55-60       | 0      | 0.00    |
| 60-65       | 0      | 0.00    |
| 65-70       | 0      | 0.00    |
| 70-75       | 0      | 0.00    |
| 75-80       | 0      | 0.00    |

|       |        |        |       |        |        |       |        |        |
|-------|--------|--------|-------|--------|--------|-------|--------|--------|
| 80-85 | 0      | 0.00   | 80-85 | 83.33  | 5.56   | 80-85 | 0      | 0.00   |
| 85-90 | 0      | 0.00   | 85-90 | 83.33  | 5.56   | 85-90 | 0      | 0.00   |
| 0-90  | 1500.0 | 100.00 | 0-90  | 1500.0 | 100.00 | 0-90  | 1500.0 | 100.00 |

  

|                    |            |
|--------------------|------------|
| Standard Deviation | 22.9061424 |
| Blendability Score | 0.00       |

|                    |       |
|--------------------|-------|
| Standard Deviation | 0     |
| Blendability Score | 10.00 |

|                    |            |
|--------------------|------------|
| Standard Deviation | 13.7549093 |
| Blendability Score | 4.00       |

**Table 1 – Illustrates how lumens are distributed through the zones of a light’s beam pattern that result in Blendability scores of 0 (very focused, intense center beam with no spill light), 10 (perfectly equal distribution of light from center to peripheral, no hot spots), and 4 (undesirable hot spots in beam pattern from poorly designed optics). 1,500 lumens is an arbitrary number used for this example.**

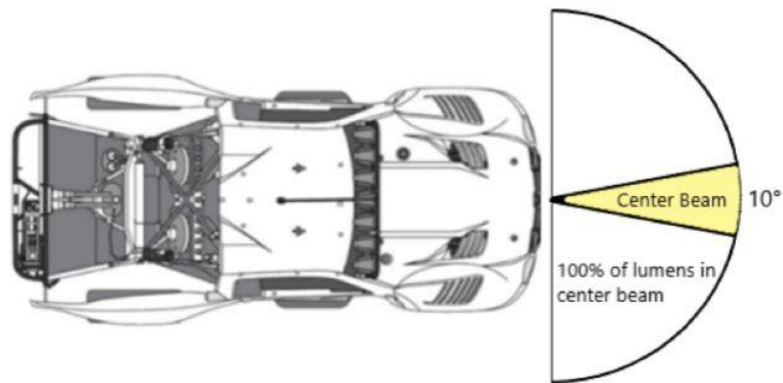

**Picture 6: Blendability score 0 Example [5]**

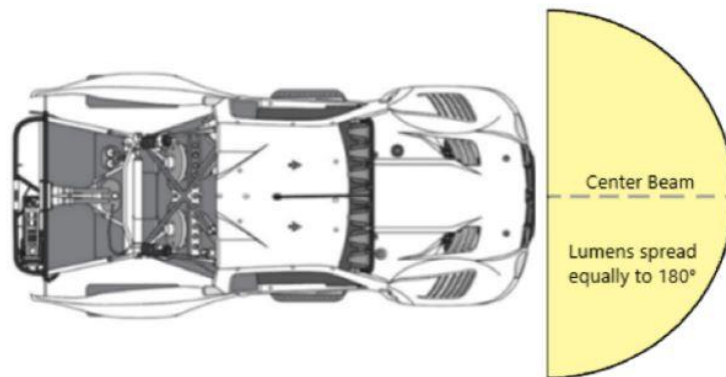

**Picture 7: Blendability score 10 Example [5]**

**Blendability Score Derivation**

Deriving Blendability is a multistep process to help define the smoothness of the light pattern as it transitions across the driver’s horizontal field of view. The mathematical derivation procedure for Blendability is outlined below:

1. Find the luminous flux in the conic solid angle in 1° increments with the light positioned at 90°. This represents the horizontal planar angle that best quantifies an offroad light's beam pattern. This step converts the luminous intensity measurements, in candela, to luminous flux (lumens). Do not average the intensity from 0° to 360° as the width of OHV lighting is much greater than the height.

$$\Phi_X = 2\pi I_{XN}(\cos \theta_{XN} - \cos \theta_{XN+1})$$

2. Sum the flux from 0-90

$$\sum_0^{90} \Phi_X (0-90)$$

3. Sum the flux in increments of 5°.

$$\sum_0^5 \Phi_X (0-5)$$

$$\sum_5^{10} \Phi_X (5-10)$$

*ect...*

4. Determine the Zonal Flux in each zone in 5° increments.

$$\frac{\sum_0^5 \Phi_X (0-5)}{\sum_0^{90} \Phi_X (0-90)} * 100 = \% \text{ Lumens}_{(0-5)}$$

5. Take the standard deviation of all zonal percentages.

$$SD = \% \text{ Lumens}_{(0-5)}, \% \text{ Lumens}_{(5-10)}, \% \text{ Lumens}_{(10-15)}, \text{ECT} \dots$$

6. Scale the standard deviation in a score from 0-10. A standard deviation of 22.9061

$$\text{Blendability} = 10 - \left(\frac{SD}{22.9061}\right) * 10$$

### Blendability Example

#### Squadron Pro Spot

1. Flux From 0-1 Degree.

$$\Phi_1 = 2\pi \frac{(96873 + 93223)}{2} (\cos(0) - \cos(1)) = 90.96 \text{ lm}$$

$$\Phi_2 = 2\pi \frac{(93223 + 74399)}{2} (\cos(1) - \cos(2)) = 240.59 \text{ lm}$$

Etc....

2. Sum Flux 0-90.

$$\sum_0^{90} \Phi_1 + \Phi_2 + \Phi_3 \dots \Phi_{90} = 3379.2 \text{ lm}$$

3. Sum Flux in 5° Increments

$$\sum_0^5 \Phi_1 + \Phi_2 + \Phi_3 + \Phi_4 + \Phi_5 = 1194.1 \text{ lm}$$

$$\sum_5^{10} \Phi_1 + \Phi_2 + \Phi_3 + \Phi_4 + \Phi_5 = 670.1 \text{ lm}$$

Etc....

4. Determine the Zonal Flux.

$$\frac{1297.9}{3379.2} = 35.34\% \text{ (Zone } 0^\circ - 5^\circ)$$

$$\frac{752.7}{3379.2} = 19.83\% \text{ (Zone } 5^\circ - 10^\circ)$$

Etc....

5. Standard Deviation

$$(35.34, 19.83, 7.47, 6.67, 7.15, \text{ ect...}) = 8.79$$

6. Scale Value

$$10 - \left(\frac{8.79}{22.9061}\right) * 10 = 6.16$$

#### Diode Dynamics SS3 Pro Spot

1. Flux From 0-1 Degree.

$$\Phi_1 = 2\pi \frac{(170913 + 158593)}{2} (\cos(0) - \cos(1)) = 158.16 \text{ lm}$$

$$\Phi_2 = 2\pi \frac{(158593 + 124310)}{2} (\cos(1) - \cos(2)) = 407.53 \text{ lm}$$

Etc....

2. Sum Flux 0-90.

$$\sum_0^{90} \Phi_1 + \Phi_2 + \Phi_3 \dots \Phi_{90} = 2156.3 \text{ lm}$$

3. Sum Flux in 5° Increments

$$\sum_0^5 \Phi_1 + \Phi_2 + \Phi_3 + \Phi_4 + \Phi_5 = 1712.5 \text{ lm}$$

$$\sum_5^{10} \Phi_1 + \Phi_2 + \Phi_3 + \Phi_4 + \Phi_5 = 245.3 \text{ lm}$$

Etc....

4. Determine the Zonal Flux.

$$\frac{1712.5}{2156.3} = 79.42\% \text{ (Zone } 0^\circ - 5^\circ)$$

$$\frac{245.3}{2156.3} = 11.37\% \text{ (Zone } 5^\circ - 10^\circ)$$

Etc....

5. Standard Deviation

$$(79.42, 11.37, 1.36, 1.45, 2.31, \text{ ect...}) = 18.10$$

6. Scale Value

$$10 - \left(\frac{18.10}{22.9061}\right) * 10 = 2.10$$

**Light Distance:** Is the distance the light's center beam travels before dimming to 10 lux of brightness. This has been a controversial specification that has been manipulated by competitors to appear more favorable in some instances. Traditionally the off-road lighting industry has measured distance where the light dims to 1 or .25 lux which allows distance values to be exaggerated but in reality, are too dim to safely drive off. The inverse square law states that the intensity of light drops with the inverse square of the distance meaning that the further the light travels the lower the intensity [4]. By choosing such a low intensity of light other off-road lighting manufacturers can claim unrealistically long-distance measurements for their lights. 1 or .25 lux is roughly equivalent to the amount of light present on a full moon. The lux rating of light is a derived unit measuring lumens per square meter where 1 lux is one lumen per square meter.

Baja Designs is establishing 10 lux as the standard to which ELS specifications are calibrated because it is roughly equivalent to the amount of light present at twilight making it a more realistic minimum amount of light the human eye can safely use for driving.

Using the inverse square law, the below example provides some context for how distances are manipulated by using .25 or 1 lux rather than an amount of light that can safely be used for driving.

1. The equation for the inverse square law is rearranged to compare distance measurements between 10 lux and 1 lux.

$$Intensity \propto \frac{1}{Distance^2}$$

Rewritten to compare distance:

$$Intensity_a \times Distance_a^2 = Intensity_b \times Distance_b^2$$

2. If Baja Designs measures one of its lights to a distance of 316.23 feet ( $Distance_a$ ) at 10 lux, how far would the distance be if measured to 1 lux ( $Intensity_b$ )?

$$Intensity_a \times Distance_a^2 = Intensity_b \times Distance_b^2$$

$$Distance_b = \sqrt{\frac{Intensity_a \times Distance_a^2}{Intensity_b}}$$

$$Distance_b = \sqrt{\frac{(10 \text{ lux}) \times (316.23 \text{ ft})^2}{1 \text{ lux}}}$$

$$Distance_b = 1,000 \text{ ft}$$

3. By measuring to a lower lux value that is too dim to drive off competitors can claim significantly longer distances. Calculating to 1 lux a gives a distance 3.16 times greater than if measured or calculated to 10 lux.



**Light output:** The Effective Lighting Score (ELS) uses Effective Lumens to quantify light output. Effective Lumens is the amount of light that can be seen after it has passed through the secondary optics (reflectors and lenses). Effective Lumens are typically lower than industry standard published lumen values, which are Raw or Theoretical Lumens. Raw or Theoretical Lumens is the light emitted by the LEDs with no optics, housing, or lenses present, which is not an accurate depiction of light seen from a complete off-road light and is therefore not the best way to quantify the performance. In every offroad light some percentage of the Raw Lumens emitted by the light's LEDs do not make it into the visible beam pattern due to internal reflection of the secondary optics, blockage by the housing or bezel, and other phenomena unique to each light. Measured lumens are derived from the illuminous flux using testing standard IESNA LM-79 [1].

### ***Test Procedure***

Each sample was tested using a Type C Mirror Goniophotometer system to measure the luminous intensity (candela) at each angle of distribution for the sample light. Measurements are taken at angles of distribution from 0 -360° in 22.5° increments. Measurements taken from the 90° angle of distribution are used to create the horizontal planar angle used in the below specifications. Electrical measurements of the unit were measured using a power analyzer. Each sample was operated at the rated input voltage of the system in its designated orientation. The ambient temperature and relative humidity were measured at 25°C ± 1.2°C and 10-65% respectively at a position within 1.5m and at equal height of the sample light. The test distance was ≥ 5x the longest luminous dimension of the sample light. All tests were performed at 1-degree vertical increments.

The standard LM-79-19 stabilization procedure to was not followed and instead the product was energized for 5 minutes before photometric measurements were taken. A fan was used on all test samples throughout testing to ensure sufficient airflow to prevent thermal management systems from engaging. Previous testing has shown that the standard LM-79 test and stabilization procedure, without air movement, results in thermal management systems activating on the lights that have it. It is possible to identify and remove thermal management systems from the test lights, but this was avoided to prevent giving any specific brand or type of light an advantage in testing.

### ***Analysis***

In Table 2 below, the average speeds of the top three racers for the seven most competitive classes racing the 53<sup>rd</sup> & 54<sup>th</sup> SCORE International Baja 1000 and 2021 Best in the Desert Vegas to Reno are shown. There were a total of 2,614 miles raced in this example leaving the Trophy Truck (TT) class with the highest average race speed at 54.9mph and UTV N/A with the lowest at 41.3mph. Vehicle speeds range anywhere from 0-120mph during these races.

|                    |         |
|--------------------|---------|
| <b>Total Miles</b> | 2,614.4 |
|--------------------|---------|

| Vehicle Average Speed (mph) by Class |      |             |         |          |           |         |
|--------------------------------------|------|-------------|---------|----------|-----------|---------|
| Pro Moto                             | TT   | Class 1     | TT Spec | Class 10 | UTV Turbo | UTV N/A |
| 49.9                                 | 54.9 | 48.3        | 50.5    | 44.7     | 41.7      | 41.3    |
| <b>Average</b>                       |      | <b>47.3</b> |         |          |           |         |

*Table 2: Average Race Vehicle Speed*

With significant portions of these races being run at night, having the correct lighting package is a critical advantage. Driving speeds and human reaction time play a large role in the performance required from the lights. Below in Table 2, are vehicle speeds with relative distances required to avoid an object within 4 seconds to see, react, and avoid the obstacle. In the following example, a complex but expected driver reaction time of 1 second is used. This is the time required for a driver to recognize an obstacle, perceive the object, and to begin to react [3]. An additional three seconds is used as a period for the driver to plan and execute maneuvers around the obstacle. For example, if a racer is driving at 100mph and sees an obstacle that requires the vehicle to be maneuvered around it, they will need to be able to see 587 feet ahead to have four seconds to recognize and react.

| Driver's Reaction Time (s) | 1                                   |
|----------------------------|-------------------------------------|
| Time to React (s)          | 3                                   |
| Vehicle Speed (mph)        | Distance Req'd To Avoid Object (ft) |
| 25                         | 0-147                               |
| 50                         | 147-293                             |
| 75                         | 293-440                             |
| 100                        | 440-587                             |
| 125                        | 587+                                |

*Table 3: Race Vehicle Speed and Relative Distance Required to Avoid Obstacle*

Below in Table 4, the Light Distances of several lights made by Baja Designs are provided. Using the "Distance Required To Avoid Object" determined in Table 2, ELS can be used to select lights that provide sufficient illumination (10 lux) at the distance(s) required to react and avoid an obstacle.

| Light         | Part Number | Effective Lumens (lm) | Distance @ 10 lux (ft) |
|---------------|-------------|-----------------------|------------------------|
| XL Sport DC   | 56-0003     | 2765                  | 342                    |
| XL Pro DC     | 50-0003     | 3764                  | 432                    |
| XL Racer Spot | 68-0002     | 1825                  | 674                    |
| XL 80 DC      | 67-0003     | 8278                  | 392                    |
| XL 80 WC      | 67-0005     | 8063                  | 202                    |
| LP4 Spot      | 29-0001     | 7953                  | 438                    |
| LP6 Pro Spot  | 27-0001     | 6926                  | 528                    |
| LP6 Pro DC    | 27-0003     | 7284                  | 471                    |
| LP9 Pro Spot  | 32-0001     | 10441                 | 778                    |
| LP9 Pro DC    | 32-0003     | 9999                  | 599                    |

**Table 4: Standard Lighting Specifications**

It is evident that the LP9 DC, LP9 Spot and XL Racer Spot can illuminate an object at 10 lux or greater at distances greater than 587 feet and therefore provide the driver in the above example more than enough usable light to see, react, and avoid the obstacle.

## **Results**

### **Zone 3 – Primary Driving Lights:**

| Light             | Zone   | Part Number | Blend Angle (Degrees) | Blendability (0 - 10) | Distance @ 10 lux (ft) | Effective Lumens (lm) |
|-------------------|--------|-------------|-----------------------|-----------------------|------------------------|-----------------------|
| S2 Sport DC       | Zone 3 | 54-0003     | 74                    | 6.31                  | 137                    | 1094                  |
| S2 Pro DC         | Zone 3 | 48-0003     | 78                    | 6.60                  | 148                    | 1774                  |
| Squadron Sport DC | Zone 3 | 55-0003     | 112                   | 7.06                  | 183                    | 2441                  |
| Squadron Pro DC   | Zone 3 | 49-0003     | 122                   | 7.21                  | 266                    | 3708                  |
| XL Sport DC       | Zone 3 | 56-0003     | 80                    | 6.40                  | 342                    | 2765                  |
| XL Pro DC         | Zone 3 | 50-0003     | 88                    | 6.56                  | 432                    | 3764                  |
| XL 80 DC          | Zone 3 | 67-0003     | 62                    | 4.99                  | 392                    | 8278                  |
| LP4 DC            | Zone 3 | 29-0003     | 136                   | 7.46                  | 395                    | 6686                  |
| LP6 Pro DC        | Zone 3 | 27-0003     | 136                   | 7.49                  | 471                    | 7284                  |
| LP9 Pro DC        | Zone 3 | 32-0003     | 142                   | 7.35                  | 599                    | 9999                  |
| S8 10in DC        | Zone 3 | 70-1003     | 116                   | 7.07                  | 323                    | 4910                  |
| OnX6+ 10in DC     | Zone 3 | 45-1003     | 88                    | 6.31                  | 570                    | 8614                  |

### **Zone 4, Zone 5, and Zone 51 – Spot Lights:**

| Light               | Zone   | Part Number | Blend Angle (Degrees) | Blendability (0 - 10) | Distance @ 10 lux (ft) | Effective Lumens (lm) |
|---------------------|--------|-------------|-----------------------|-----------------------|------------------------|-----------------------|
| S1 Spot             | Zone 4 | 38-0001     | 72                    | 6.09                  | 155                    | 1927                  |
| S2 Sport Spot       | Zone 4 | 54-0001     | 72                    | 5.76                  | 173                    | 1058                  |
| S2 Pro Spot         | Zone 4 | 48-0001     | 80                    | 6.20                  | 193                    | 1955                  |
| Squadron Sport Spot | Zone 4 | 55-0001     | 82                    | 6.01                  | 229                    | 1957                  |
| Squadron Pro Spot   | Zone 4 | 49-0001     | 86                    | 6.16                  | 323                    | 3443                  |
| Squadron Racer Spot | Zone 5 | 72-0001     | 84                    | 5.15                  | 374                    | 1765                  |
| XL Sport Spot       | Zone 4 | 56-0001     | 60                    | 3.93                  | 418                    | 2253                  |
| XL Pro Spot         | Zone 4 | 50-0001     | 60                    | 4.13                  | 498                    | 3228                  |
| XL Racer Spot       | Zone 5 | 68-0002     | 58                    | 2.35                  | 674                    | 1825                  |
| XL 80 Spot          | Zone 4 | 67-0001     | 64                    | 5.04                  | 448                    | 9090                  |
| LP4 Spot            | Zone 4 | 29-0001     | 134                   | 6.72                  | 438                    | 7953                  |
| LP6 Pro Spot        | Zone 4 | 27-0001     | 134                   | 6.62                  | 528                    | 6926                  |
| LP9 Pro Spot        | Zone 4 | 32-0001     | 140                   | 6.78                  | 778                    | 10441                 |

|                             |         |         |     |      |     |       |
|-----------------------------|---------|---------|-----|------|-----|-------|
| S8 10in Spot                | Zone 4  | 70-1001 | 88  | 6.22 | 329 | 4690  |
| OnX6+ 10in Spot             | Zone 4  | 45-1001 | 64  | 4.91 | 607 | 9364  |
| OnX6+ 10in Laser            | Zone 51 | 41-1007 | 70  | 2.43 | 611 | 4049  |
| OnX6+ 10in Hybrid laser     | Zone 51 | 45-1007 | 86  | 6.43 | 627 | 6353  |
| Diode Dynamics SS3 Pro Spot |         |         | 102 | 2.10 | 429 | 2164  |
| Diode Dynamics SSC1 Spot    |         |         | 48  | 4.28 | 177 | 1737  |
| Heretic 10in LED            |         |         | 88  | 5.19 | 437 | 3554  |
| Heretic Quattro Pod         |         |         | 78  | 5.87 | 215 | 1326  |
| Rigid 10in E-series         |         | 110213  | 92  | 5.65 | 436 | 10811 |
| Rigid SR Lightbar           |         | 910213  | 114 | 4.76 | 415 | 5036  |
| Rigid Ignite Spot           |         | 20511   | 66  | 5.16 | 123 | 782   |

### Zone 1, Zone 2, and Zone 7 – Nearfield & Peripheral Lights:

| Light             | Zone        | Part Number | Blend Angle (Degrees) | Blendability (0 - 10) | Distance @ 10 lux (ft) | Measured Lumens (lm) |
|-------------------|-------------|-------------|-----------------------|-----------------------|------------------------|----------------------|
| S2 Sport WC       | Zone 1 or 2 | 54-0005     | 72                    | 7.12                  | 80                     | 1112                 |
| S2 Pro WC         | Zone 1 or 2 | 48-0005     | 76                    | 7.15                  | 97                     | 1814                 |
| Squadron Sport WC | Zone 1 or 2 | 55-0005     | 124                   | 6.65                  | 114                    | 2506                 |
| Squadron Sport WS | Zone 7      | 55-0006     | 126                   | 7.95                  | 50                     | 2427                 |
| XL Pro WC         | Zone 1 or 2 | 50-0005     | 102                   | 5.81                  | 162                    | 3363                 |
| XL 80 WC          | Zone 1 or 2 | 67-0005     | 66                    | 6.07                  | 202                    | 8063                 |
| S8 10in WC        | Zone 1 or 2 | 70-1004     | 126                   | 6.54                  | 158                    | 4595                 |
| S8 10in WS        | Zone 7      | 70-1006     | 144                   | 7.89                  | 74                     | 4927                 |

### Discussion of Results

The primary purpose of ELS is to present a variety of data that fully characterize the performance of off-road lights and can be used to select the best lights for each lighting Zone (see Zone Chart, Appendix A). As no single component of Effective Lighting Scores will tell a user which light(s) will be the best for their application it is necessary to consider all components of ELS when selecting light(s). To provide context for how ELS can be used to build a lighting package the below results and observations should be considered:

- When building a lighting package, the first light(s) that should go on a vehicle are the **Zone 3 lights** which are the vehicle's primary driving lights. These lights will typically use a Driving Combo (DC) lens that provides a balance of near field and distance lighting by incorporating both Wide Cornering (Zone 1) and Spot (Zone 4) areas. When selecting a Zone 3 light it is critical to consider the vehicle type, speeds, and terrains.

- Start by reviewing the ELS Blend Angle values for Driving Combo lights. Zone 3 lights using Driving Combo lenses will have higher Blend Angles than Zone 4, Zone 5, and Zone 51 lights (Spot and Laser lights). Due to the Wide Cornering areas included in Driving Combo lenses, Baja Designs Zone 3 lights will have Blend Angles comparable to Zone 1 or Zone 2 lights. A well-balanced primary driving light should have a Blend Angle width ranging from **65 - 130°** \*\*.
  - The expected range of Blend Angle values calculated from **Zone 3 auxiliary lights** tested is **46 - 127°** (mean Blend Angle of lights tested of 86° +/- 3 standard deviations).
  - The expected range of Blend Angle values calculated from **Zone 3 light bars** tested is **60 - 144°** (mean Blend Angle of lights tested of 102° +/- 3 standard deviations).
  - The recommended range of Blend Angle values is based on a combination of measured values and driving/field testing. As more lights are tested and added to the ELS tables the range of calculated values using mean and three-sigma standard deviation method will evolve and may not remain as currently stated.
    - The mean of the data set plus or minus three standard deviations will account for 99.73% of lights expected to be in the range for that light type (Zone 3 in this case).
  - \*\* The LP Series Driving Combo lights have Blend Angles exceeding 135° due to dedicated LEDs and Integrated Peripheral Technology (IPT™) reflectors that focus light into peripheral zones. LP Driving Combo lights are excluded from Blend Angle calculations due to these features.
- Combining nearfield light (Zone 1 and Zone 2) and distance lighting (Zone 4 and Zone 5) to create midfield lighting that is spread widely enough to comfortably drive off means that it is important to select lights whose beam patterns have smooth transitions from the center beam to peripheral and near field regions. Zone 3 lights should have high **Blendability** values from **5.0 – 8.0**.
  - The expected range of Blendability values calculated from **auxiliary lights** tested is **5.6 – 8.1** (mean Blendability of lights tested of 6.9 +/- 3 standard deviations).
  - The expected range of Blendability values calculated from **light bars** tested is **5.6 – 7.8** (mean Blendability of lights tested of 6.7 +/- 3 standard deviations).
  - Values lower than 5.0 would be indicative of a narrow beam pattern with reduced peripheral light. This doesn't necessarily mean that it is a deficient light, rather scores lower than 5.0 may indicate that that the light is a dedicated distance light (Zone 4 or Zone 5). Think of the laser pointer that has no peripheral light example used to describe a Blendability score of 0. It is important to check the other values provided in the Effective Lighting Score (a light with a Blendability value below 5.0 and distance value exceeding that of the Zone 3 lights may make this a good Zone 4 or Zone 5 light choice).
  - Inadequately designed optics may also cause low Blendability scores by creating severe bright spots, dark spots, and sharp cutoffs that result from light being shined unevenly through the beam pattern (refer to Table 1). As primary driving

- lights, these values and characteristics cause driver fatigue. Lights in this range are not appropriate for use as primary driving lights.
- Values in the range of 8.0 – 10.0 should not be selected for primary driving lights. This is due to the severely reduced distance that lights approaching values of 8.0 or above tend to possess (such as Work/Scene lights). While no lights tested had Blendability scores in the range of 8.0 – 10.0 there is a consistent correlation that as a Blendability score exceeds 7.1 there is a drop in distance. The recommended range of 5.0 – 8.0 considers lights such as the LP Series using Driving Combo lenses to achieve Blendability scores higher than 7.3 by using dedicated peripheral LEDs, distance LEDs, and wide cornering lens overlays to create very smooth transitions from the center beam to peripheral regions of the beam pattern while also illuminating extreme distances.
  - The **Distance** that Zone 3 primary driving lights illuminate to a minimum of 10 lux should account for the intended vehicle and driving style. There is no set or recommended range. For instance, greater distances will need to be illuminated when driving a pre-runner at high speed across open desert than if driving a utility side-by-side through wooded two track. Driving speeds and human reaction time play a large role in the performance required from the lights. Refer to Table 2 above to determine the approximate Distance that is required from the light(s).
  - When selecting Zone 3 lights it is important to consider the total **Light Output** from each light. ELS provides the Effective Lumens that are distributed in each light's beam pattern according to the Blend Angle and Blendability scores. Because Zone 3 lights are the primary driving lights it is critical to select lights that emit a sufficient number of lumens to satisfy the Blend Distribution and Distance requirements described above. More Effective Lumens will correlate to a better light or lighting package.
- **Spot lights (Zones 4 and Zone 5)** are added to lighting packages when it becomes necessary to increase illumination further down the road or trail. These lights should be used as supplemental lights to Zone 3 primary driving lights. Zone 4 and Zone 5 lights are designed to focus lumens into relatively narrow beam patterns and provide intense illumination at distance. Peripheral light is sacrificed to provide increased illumination at distance. These characteristics make Spot lights great supplements to a lighting package, especially when driving at high speeds or when searching, but do not work well as primary driving lights because they do not spread light into the nearfield and midfield distances (Zone 1, Zone 2, and Zone 3).
- Zone 4 and Zone 5 lights are designed to focus a higher percentage of lumens output by the LEDs into the center beam. The inverse square law used above dictates that that focusing a higher percentage of lumens into the center beam will result in illuminating greater distances to 10 lux, however, there will be a corresponding decrease in Blend Angle range. A dedicated **Zone 4 or Zone 5 auxiliary distance light** should have a Blend Angle width ranging from **50 - 100°**. A dedicated **Zone 4 or Zone 5 distance light bar** should have a Blend Angle width ranging from **60 - 110°**.
    - The range of Blend Angle values calculated from **Zone 4 and Zone 5 auxiliary lights** tested is **37 - 95°** (mean Blend Angle of lights tested of 66° +/- 3 standard deviations).

- LP Series lights are not included in calculations because of the dedicated LEDs and Integrated Peripheral Technology (IPT™) reflectors that result in Blend Angles >134° even with Spot optics.
- The range of Blend Angle values calculated from **Zone 4 and Zone 5 light bars** tested is **62 - 108°** (mean Blend Angle of lights tested of 85° +/- 3 standard deviations).
  - The effect of the LEDs in light bars being arranged in a flat horizontal configuration is suspected to be a contributing factor for why Zone 4 and Zone 5 light bars have increased Blend Angles over Zone 4 and Zone 5 auxiliary lights. All light bars in these tests are 10" in length. The magnitude of this effect on light bar Blend Angles has not been evaluated in longer light bars (20", 30", 40", 50", 60") due to test equipment limitations.
- While Zone 4 and Zone 5 lights focus a higher percentage of lumens into the center beam to increase Distance illumination, a higher Blendability score is still better. This is because an excessively bright center beam with sharp cutoffs or relatively dim peripheral light will cause eye strain and/or driver fatigue. With inadequate peripheral light and low Blendability scores more lights will need to be installed on the vehicle to create sufficient Zone 4 and Zone 5 lighting. Zone 4 and Zone 5 lights should have **Blendability** values from **3.0 – 7.0**. Refer to Pictures 8 and 9, below, to show how increased Blendability and Blend Angle provide an advantage while driving.
  - The range of **Blendability** values calculated from **Zone 4 and Zone 5 auxiliary lights** tested is **3.0 – 8.0** (mean Blendability of lights tested of 5.3 +/- 3 standard deviations).
  - The range of **Blendability** values calculated from **Zone 4 and Zone 5 light bars** tested is **3.7 – 6.9** (mean Blendability of lights tested of 5.3 +/- 3 standard deviations).
    - Zone 5 and Zone 51 lights may have Blendability values lower than 3.0 (see XL Racer Spot) because they are designed to shine light at extreme distances. These lights focus a higher percentage of lumens into the center beam (>70%) and sacrifice transitional light to achieve greater distances than even Zone 4 Spot lights. Zone 4 Spot lights will focus 25 – 60% of the available lumens into the center beam sacrificing some distance to create a smoother beam pattern with more transitional light.
    - It is important to note that lights such as the LP and OnX6+ series are capable of functioning as Zone 1, Zone 2, Zone 3, Zone 4, or Zone 5 lights depending on the lens and configuration used.
- When selecting Zone 4 and/or Zone 5 lights Distance is a key value to consider because these lights are providing illumination beyond the Zone 3 lights. Zone 4 and Zone 5 lights should illuminate distances greater than the package's Zone 3 lights.
  - On average Baja Designs Zone 4 and Zone 5 lights (using spot lenses) illuminate distances 17% greater than Zone 3 lights (using driving combo lenses) within the same product series.

- Zone 4 and Zone 5 lights focus light into tighter patterns further down range. As a result, these lights do not necessarily require as many effective lumens as the Zone 3 lights (see Squadron Pro Spot versus Squadron Racer distance and lumen values), however, as in the case of Zone 3 lights more lumens generally will provide a better light either through increased distance or increased peripheral/transitional light.



***Picture 8: Rendering of a pair of Baja Designs S1 Spot lights (Zone 4, Blend Angle 72°, Blendability 6.1) created from .IES test measurement files. Notice the illuminated objects in the transitional light outside of the bright center beam (circled in red) then refer to Picture 9 showing pair of Diode Dynamics SS1 Pro Spot lights in the same environment.***



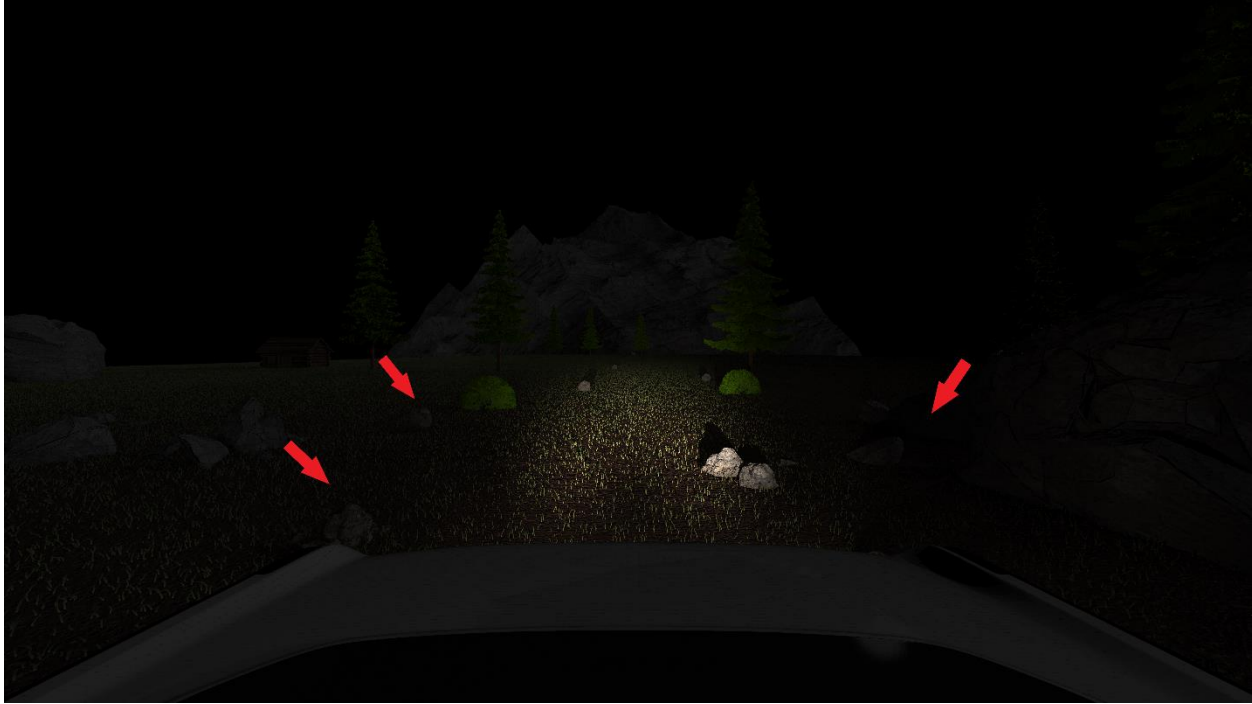

*Picture 9: Rendering of a pair of Diode Dynamics Pro Spot lights (Zone 4, Blend Angle 48°, Blendability 4.3) created from .IES test measurement files. Notice how the objects circled in the Picture 8 are not visible due to reduced Blend Angle and Blendability (same objects highlighted by red arrows in this picture).*

- **Dust/Fog (Zone 1) and Wide Cornering (Zone 2)** should never be used as primary driving lights. These lights supplement to Zone 3 lights when it is necessary to increase nearfield and peripheral illumination. Zone 1 wide cornering lights cut through fog, rain, snow, and dust directly ahead of the vehicle providing additional fill light to the Zone 3 lights. Zone 2 lights illuminate the nearfield areas that the driver needs to see while turning or cornering. Baja Designs Zone 1 and Zone 2 lights use Wide Cornering lenses to distribute lumens output by the LEDs into a wide very evenly spread pattern with a large Blend Angle, large Blendability score, and reduced Distance. Competitors use their own proprietary “diffuse” or “flood” lens patterns to create nearfield/peripheral lighting and typically do not use the term “Wide Cornering” for these lighting zones.
  - o Zone 1 and Zone 2 lights using Wide Cornering lenses will have increased Blend Angles relative to Zone 4 and Zone 5 lights. In some cases, the Zone 1 and Zone 2 lights tested have similar Blend Angles to the Zone 3 lights using Driving Combo lenses in the same product series. This is because the Driving Combo lenses used for Zone 3 lighting use the same Wide Cornering lens pattern on part of the lens as the full Wide Cornering lenses used in Zone 1 and Zone 2 lighting (see Picture 10). A dedicated **Zone 1 or Zone 2 light** should have a **Blend Angle** width ranging from **65 - 150°**.
    - The range of Blend Angle values calculated from **Zone 1 and Zone 2 lights** tested is **50 - 148°** (mean Blend Angle of lights tested of 99° +/- 3 standard deviations).

- Baja Designs Zone 1 and Zone 2 lights using full Wide Cornering lenses will have Blend Angles 6.1% higher on average than the same light using a Driving Combo lens.

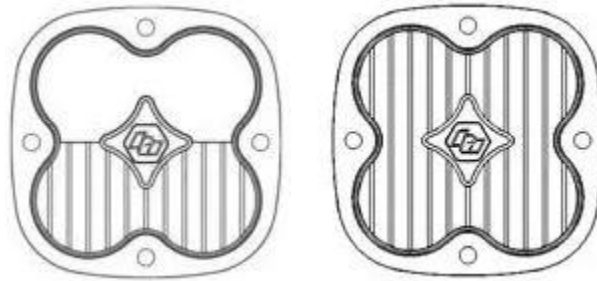

*Picture 10: Example of Zone 3 Driving Combo lens (left) that uses partial Spot lens (no pattern) on top and Wide Cornering lens pattern on bottom portion of lens. To the right is an example Zone 1/Zone2 Wide Cornering lens that uses Wide cornering pattern on full lens surface*

- Zone 1 and Zone 2 lights use patterned lenses to refract the light emitted by the LEDs to reduce center beam intensity and increase the spread of light and the evenness of that spread of light. This results in reduced center beam intensity and increased spread of lumens out from the light's photometric center to 90°. In a lighting package the Zone 1 and Zone 2 lights should have a Blendability score that is equivalent to or exceeds the Zone 3 lights. **Zone 1 and Zone 2 lights** should have **Blendability** values from **6.0 – 10.0**.
  - The range of **Blendability** values calculated from **Zone 1 and Zone 2 lights** tested is **5.5 – 7.7** (mean Blendability of lights tested of 6.6 +/- 3 standard deviations).
  - It should be noted that Blendability scores for Zone 1 and Zone 2 lights could range up to 10.0, but the limitation would then become distance. As shown in the data above there being a strong correlation between Blendability scores greater than 7.0 and reduced distance. Selecting a light with Blendability greater than 7.4 would require careful consideration of the distance that the light shines to ensure that there is sufficient distance for nearfield lighting even with lower cornering speeds.
- When selecting **Zone 1 and/or Zone 2 lights** the importance of **Distance** is reduced because these lights are diffusing light rather than focusing it to provide illumination nearer to the front of the vehicle than the Zone 3 lights. Zone 1 and Zone 2 lights should illuminate distances less than the package's Zone 3 lights.
  - On average Baja Designs Zone 1 and Zone 2 lights (using Wide Cornering lenses) illuminate distances 91% shorter, on average, than Zone 3 lights (using Driving Combo lenses) and 125% shorter than Zone 4 lights within the same product series.
  - When selecting Zone 1 and Zone 2 lights an increased emphasis should be placed on higher Blend Angle and Blendability values rather than Distance values.

- Zone 1 and Zone 2 lights focus light into broad, even patterns near the front and front corners of the vehicle. With the center beam intensity reduced and spread evenly into other zones closer to 90° from center, lights with higher lumen values will generally provide better performance. Improved performance means that the Zone 1 and Zone 2 lights evenly fill in the aforementioned areas near the front of the vehicle and overlap with the Zone 3 lights nearfield illumination effectively eliminating all bright/dark spots. ELS can be used to determine if the Zone 1 and/or Zone 2 lights provide sufficient pattern width (Beam Angle), even spread of light (Blendability), that the light shines far enough to overlap with Zone 3 lights without being excessive (Distance), and that the light has sufficient output to suit the needs of the lighting package (Effective Lumens).
  - Lights with high effective lumen values are not necessarily desirable for Zone 1 lighting solutions because of the potential glare or reflected light returned by the particulates in the air that the driver is trying to see through. The goal is to have just enough light to comfortably see objects near the vehicle through dust/precipitation.

**Work Scene (Zone 7)** lights are used to illuminate the work area immediately around the vehicle. These lights are not included in the scope of this article because they are not used for driving. Test values included above are shown to illustrate high Blend Angle score, high Blendability scores, and reduced Distance scores.

## References

- [1] ANSI. *Approved Method: Optical and Electrical Measurements of Solid-State Lighting Products*.
- [2] ANSI. *Lighting Science: Calculation of Light and Its Effects*. 5 Apr. 2021.
- [3] Gruyter, De. "Drivers 'Reaction Time Research in the Conditions in the Real Traffic." *Www.degruyter.com*, 31 Jan. 2020, [www.degruyter.com/document/doi/10.1515/eng-2020-0004/html](http://www.degruyter.com/document/doi/10.1515/eng-2020-0004/html). Accessed 18 Jan. 2022.
- [4] Voudoukis, N. *Inverse square law for light and radiation: A unifying educational approach*. European Journal of Engineering Research and Science. Nov 2017. . 2. 10.24018/ejers.2017.2.11.517.
- [5] *Ford F-150 Trophy Truck 2014 Blueprint*, May 2022. Drawing.  
<https://drawingdatabase.com/ford-f-150-trophy-truck-2014/>

## APPENDIX A

### Baja Designs Lighting Zone Charts

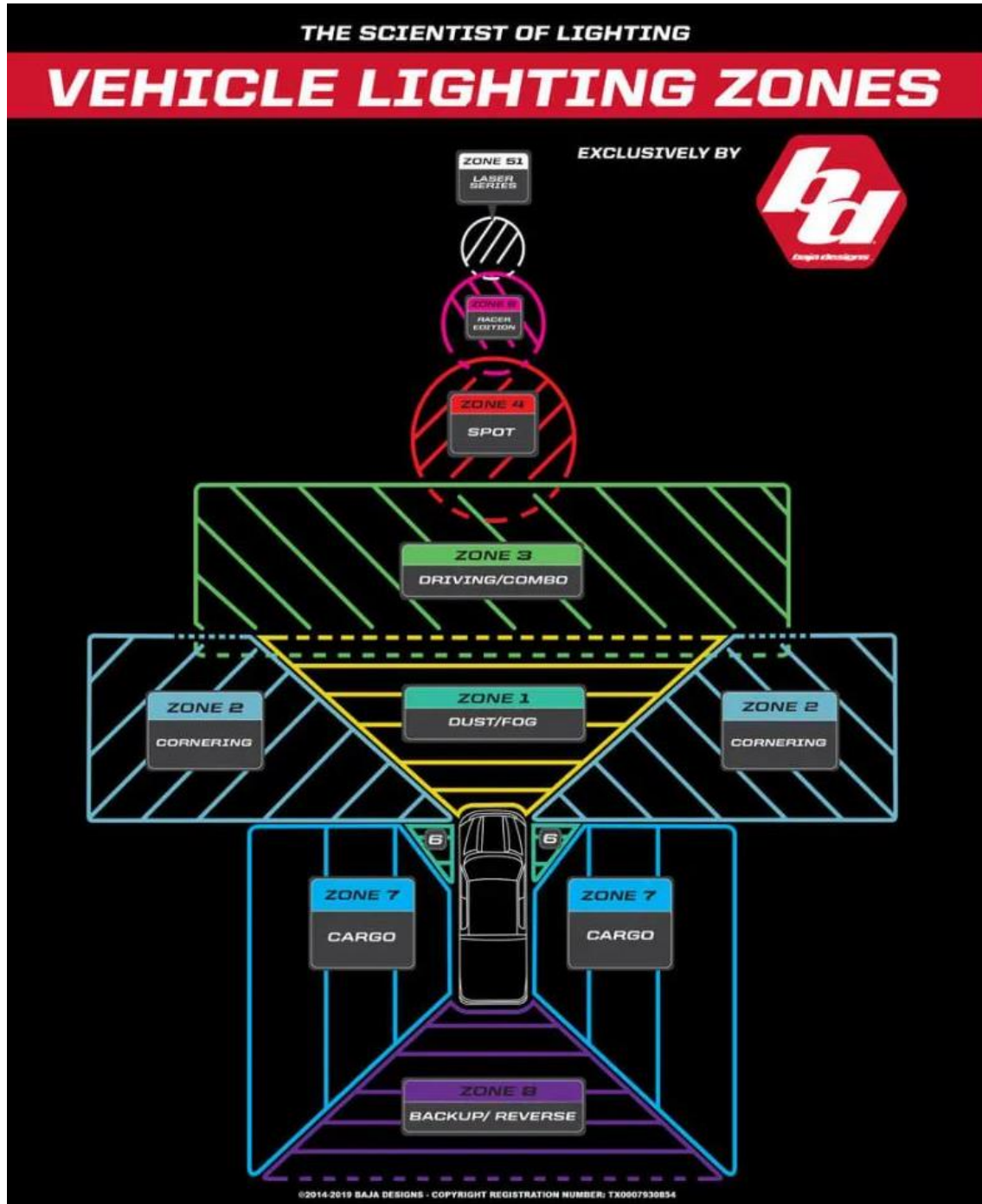

## APPENDIX A

### Baja Designs Lighting Zone Charts

